

PanaCast 50

Bildschirmhalterung

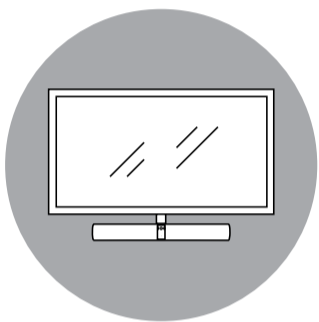

Comhead Headset Company GmbH
Die Headset Spezialisten
Borsteler Chaussee 51 | 22453 Hamburg | Tel.: (040) 500 580 20
www.comhead.de



Befestigung unter dem Bildschirm
Beginnen Sie auf Seite 1 →

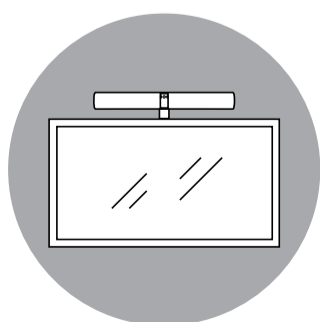
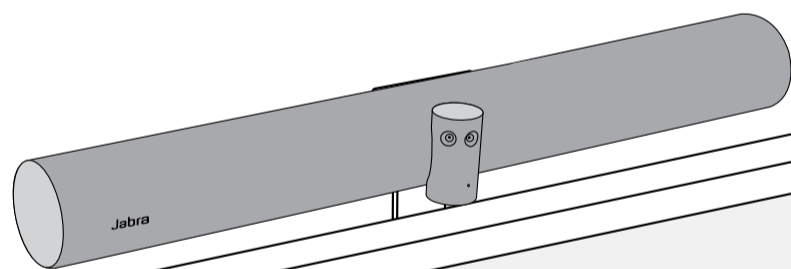
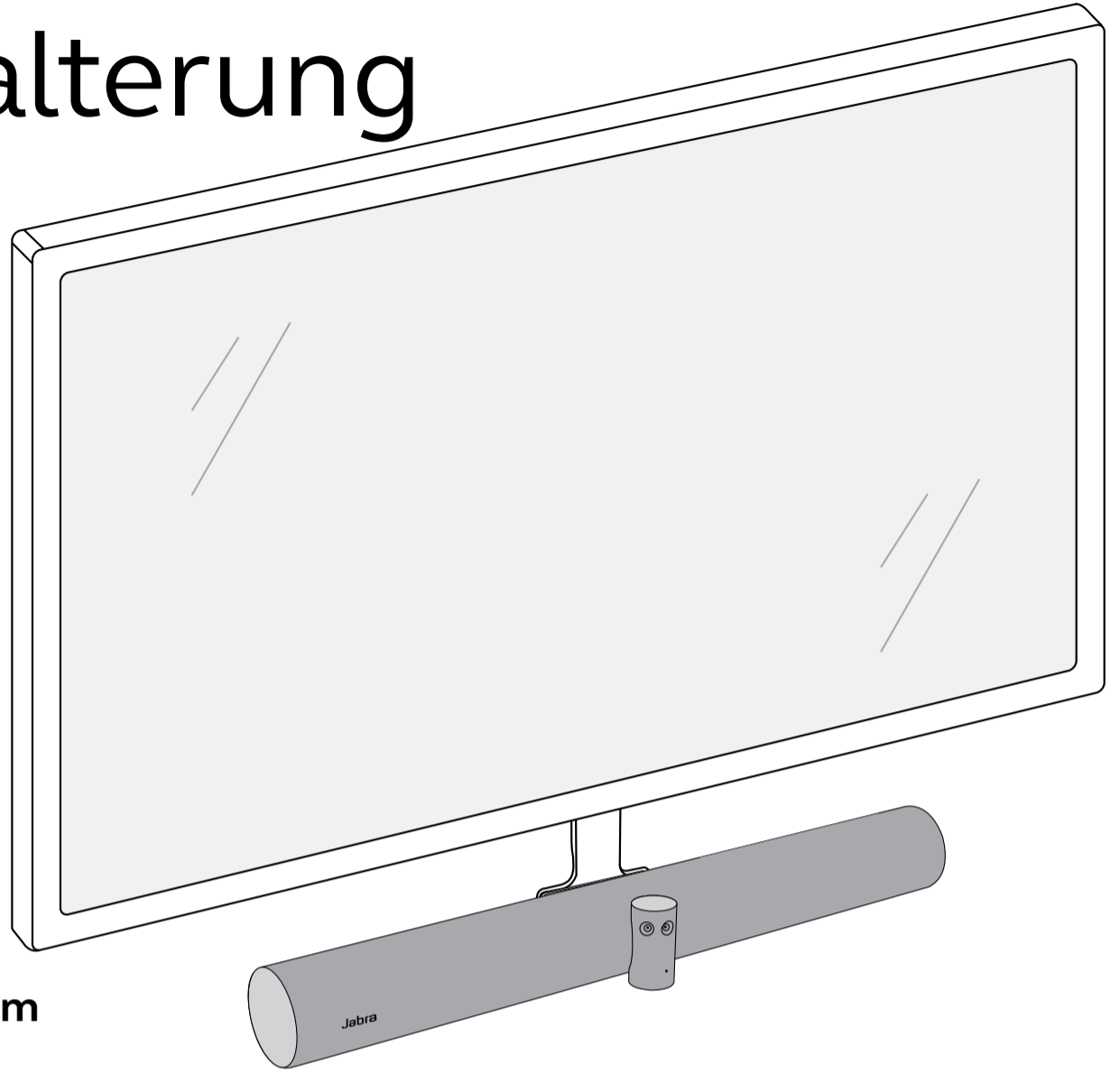

Befestigung über dem Bildschirm
Beginnen Sie auf Seite 7 →

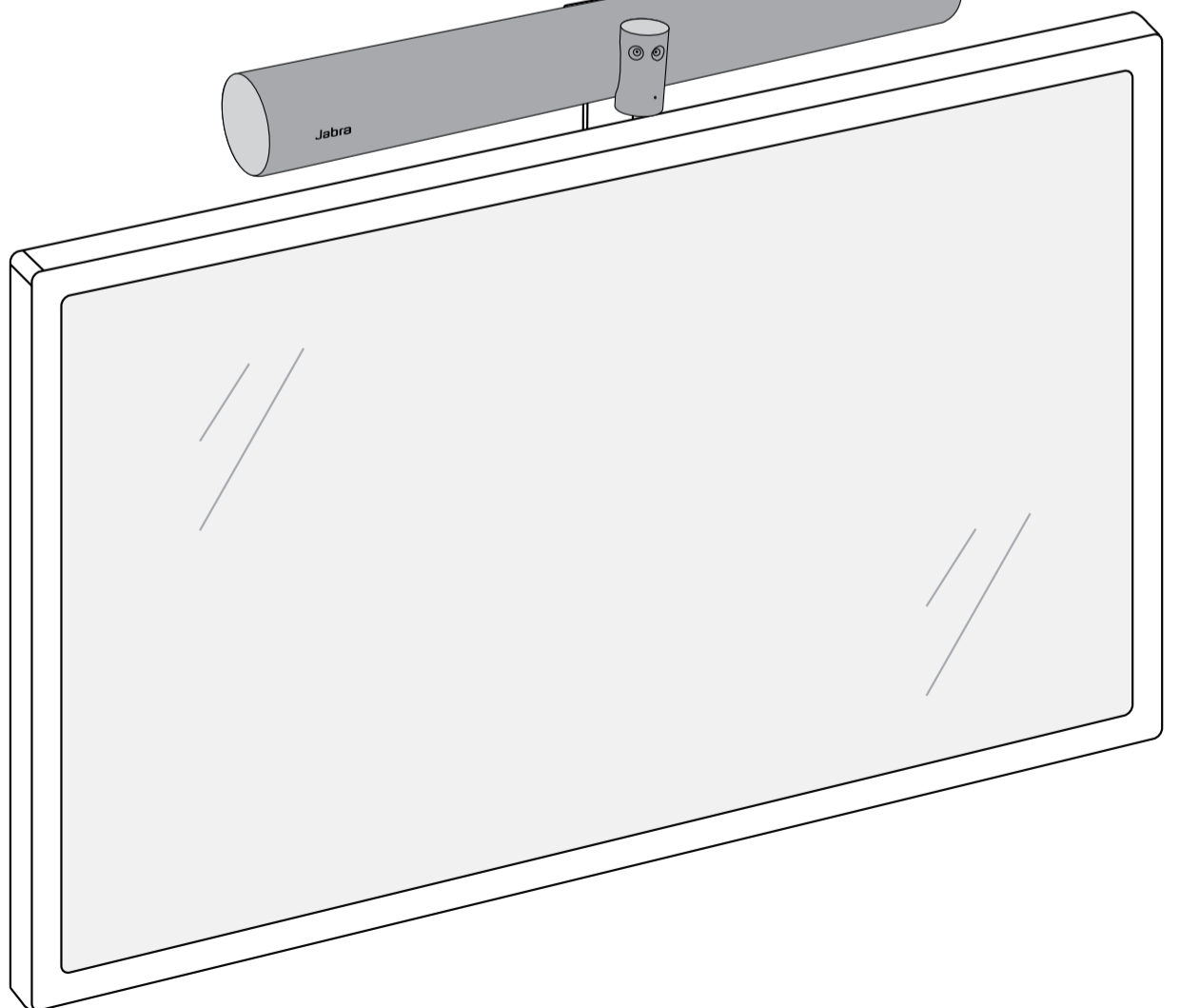

Bildschirmhalterung, horizontaler Abschnitt

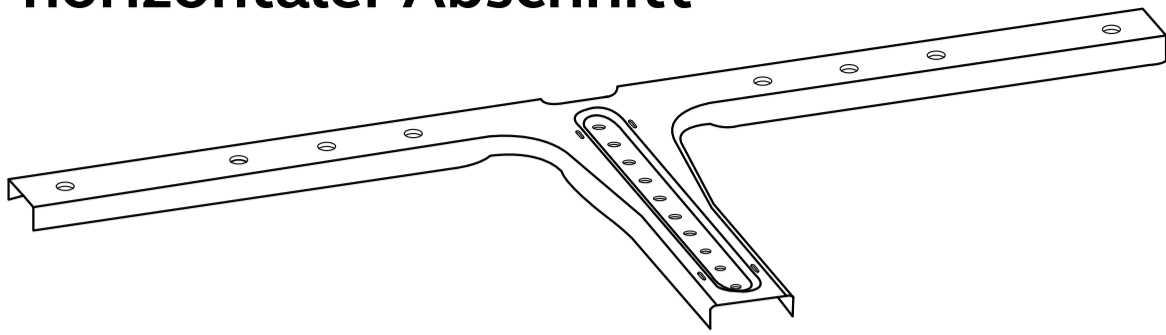

Bildschirmhalterung, vertikaler Abschnitt

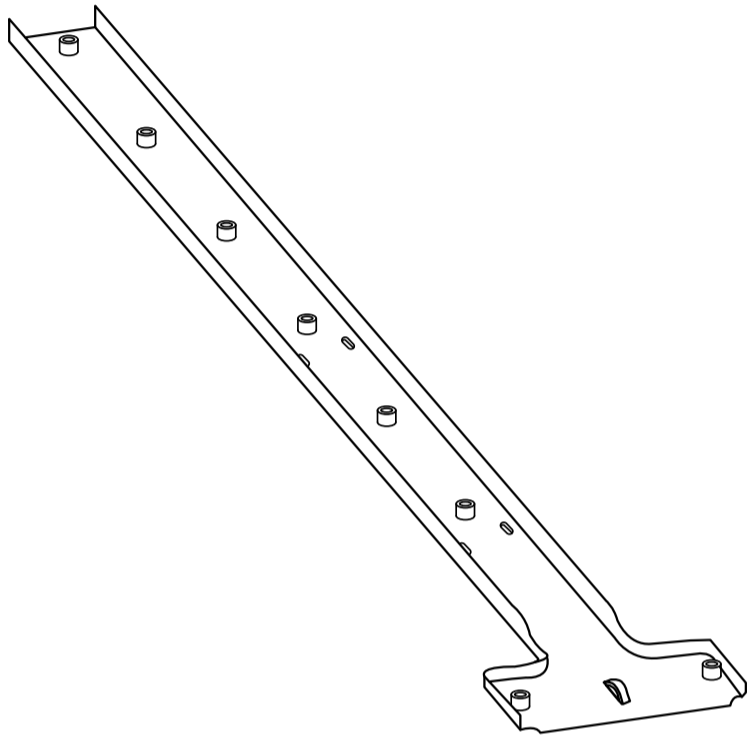

Schrauben



M6x30
(4 Stck.)

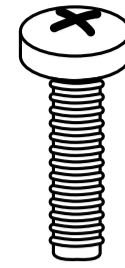

M6x40
(4 Stck.)

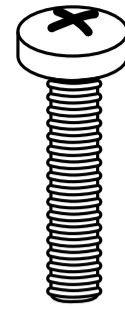

M6x50
(4 Stck.)

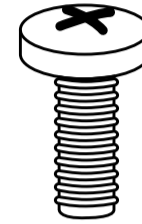

M8x30
(4 Stck.)

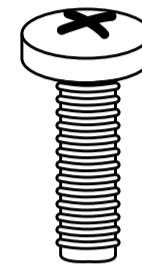

M8x40
(4 Stck.)

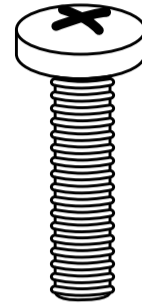

M8x50
(4 Stck.)



M5x8
(2 Stck.)

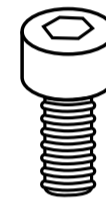

M5x12
(2 Stck.)

Abstandhalter

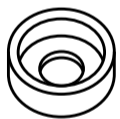

2 mm
(2 Stck.)



5 mm
(4 Stck.)



12 mm
(2 Stck.)

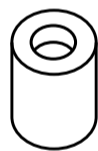

22 mm
(4 Stck.)



32 mm
(4 Stck.)

Unterlegscheiben



M6
(4 Stck.)



M8
(4 Stck.)

Schutzpolster



(2 Stck.)

Erforderliche Werkzeuge (nicht im Lieferumfang enthalten)

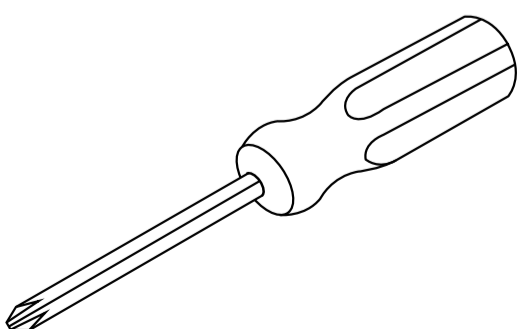

Kreuzschlitzschraubenzieher

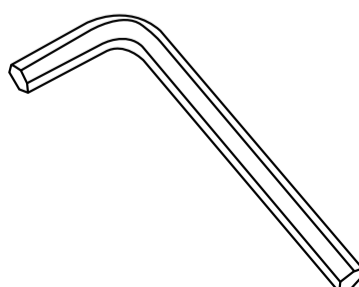

4-mm-Sechskantschlüssel

1

Wenn der Bildschirm bereits an der Wand montiert ist, nehmen Sie ihn von der Wand ab.

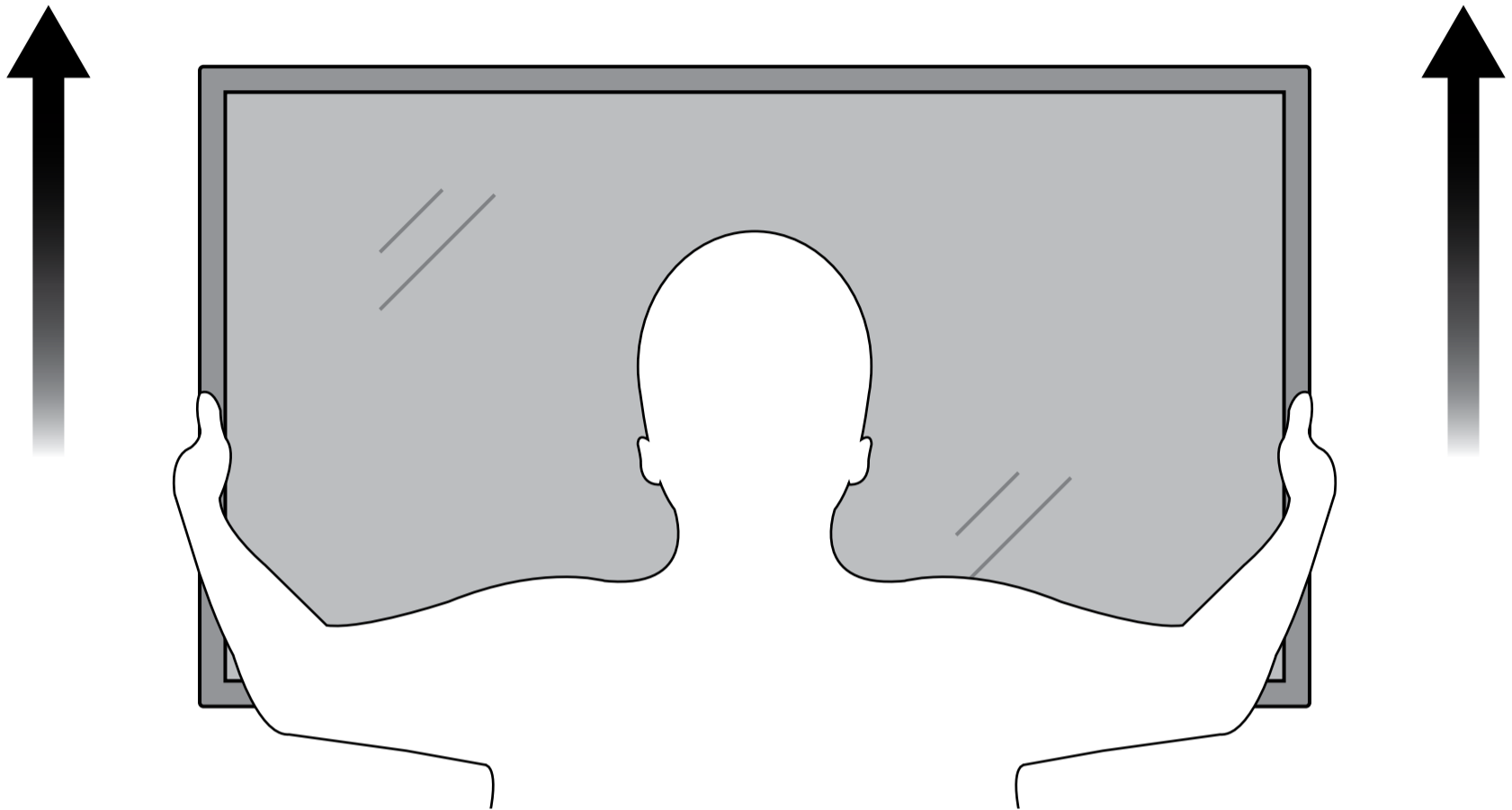
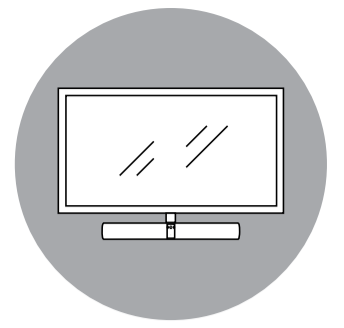

2

Entfernen Sie die vorhandene **VESA-Halterung** von Ihrem Bildschirm.

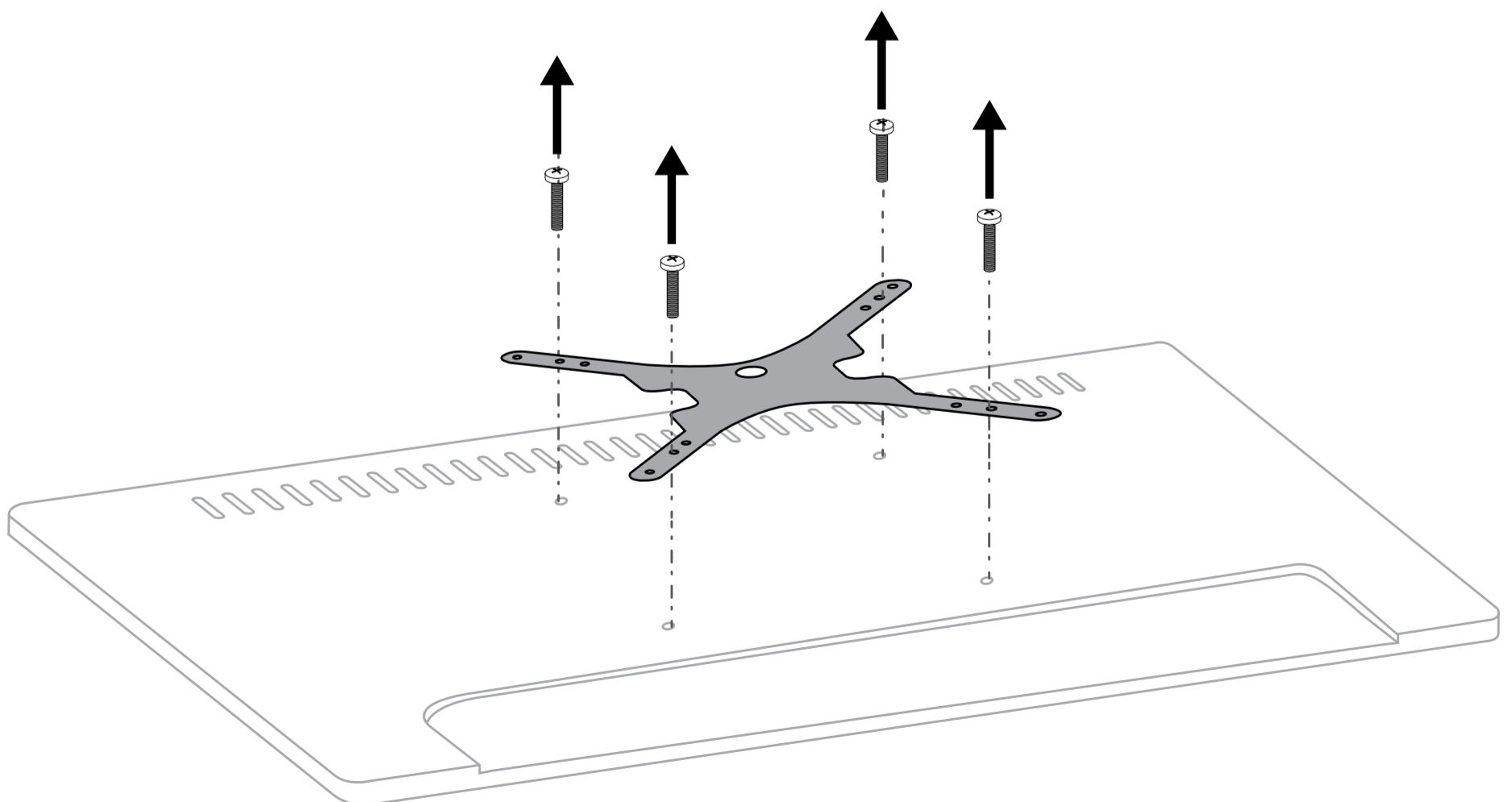

3

Messen Sie den Abstand zwischen dem Bohrloch der VESA-Halterung und dem unteren Bildschirmrand. Dieser Abstand ist **X**.

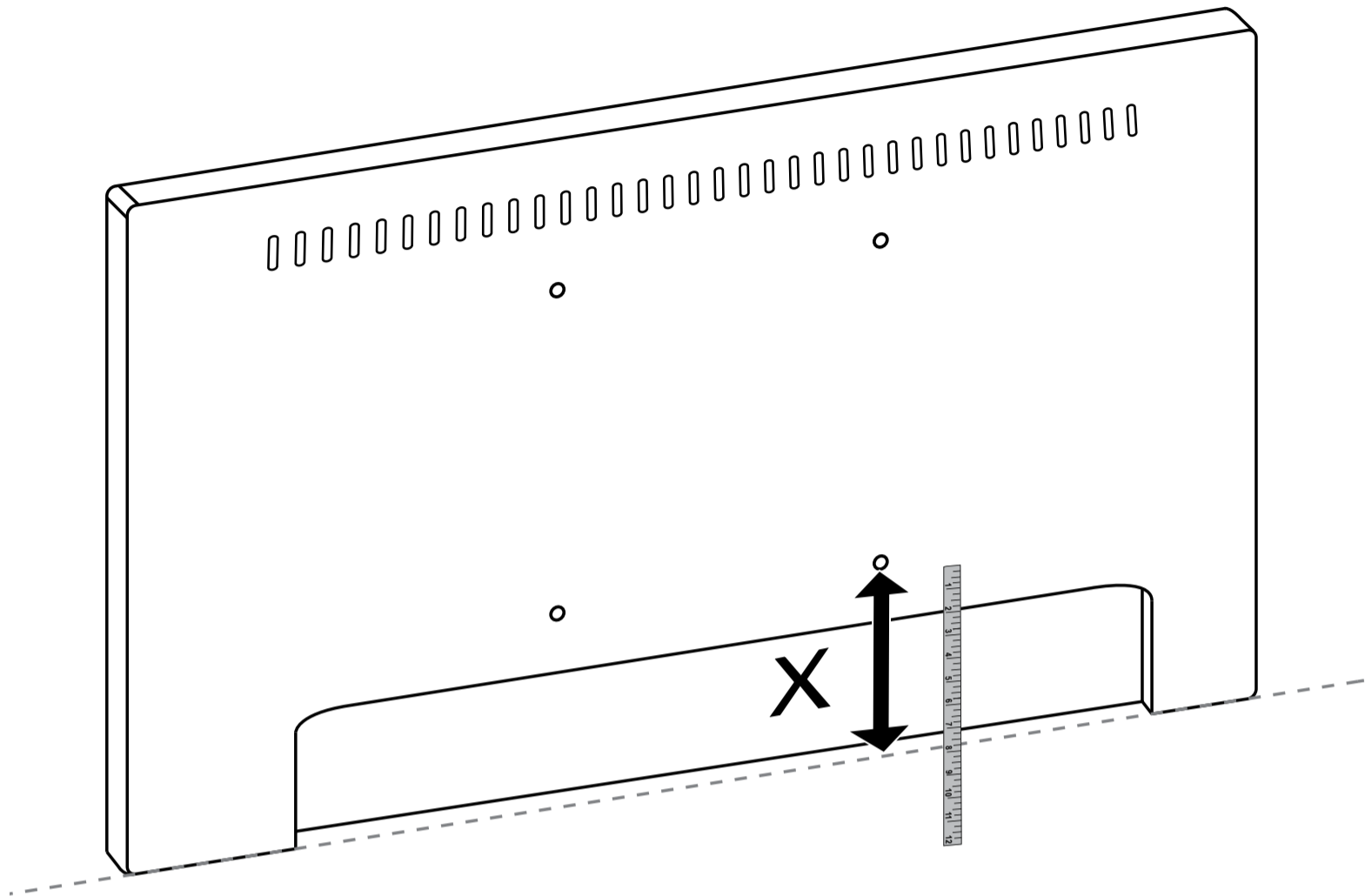
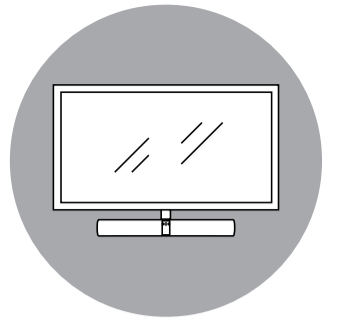

4

Bauen Sie die Bildschirmhalterung zusammen und vergewissern Sie sich, dass der angezeigte Abstand ungefähr **X + 10 cm** beträgt.

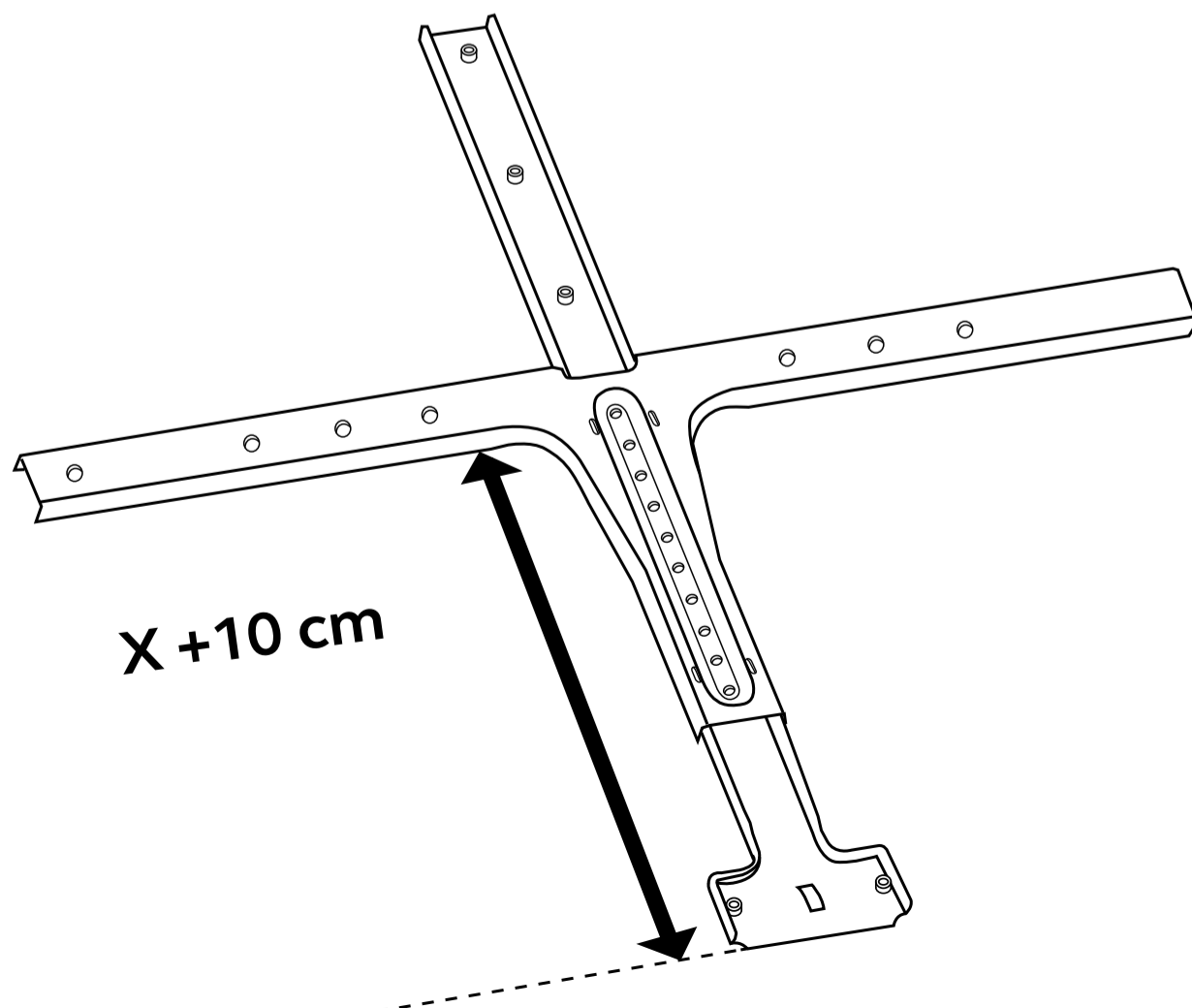
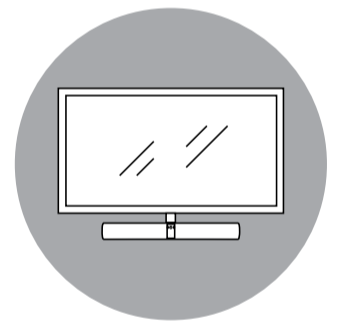

5

Schrauben Sie den horizontalen und den vertikalen Abschnitt mithilfe der mitgelieferten **M5x8-Schrauben** und eines **4-mm-Sechskantschlüssels** zusammen.

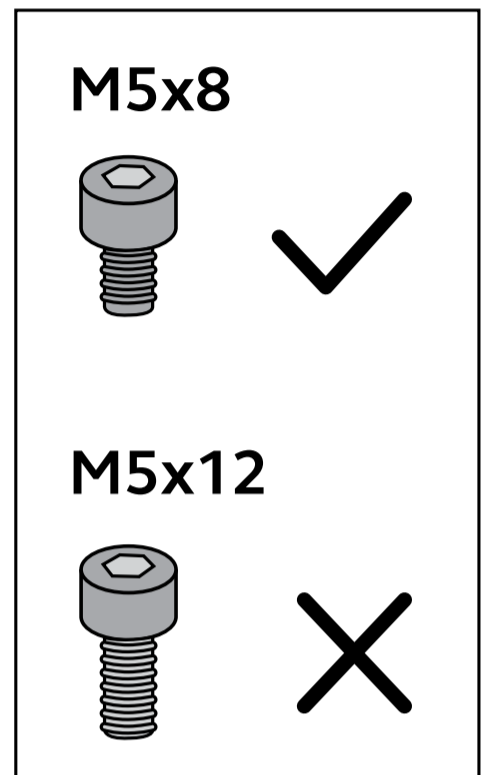
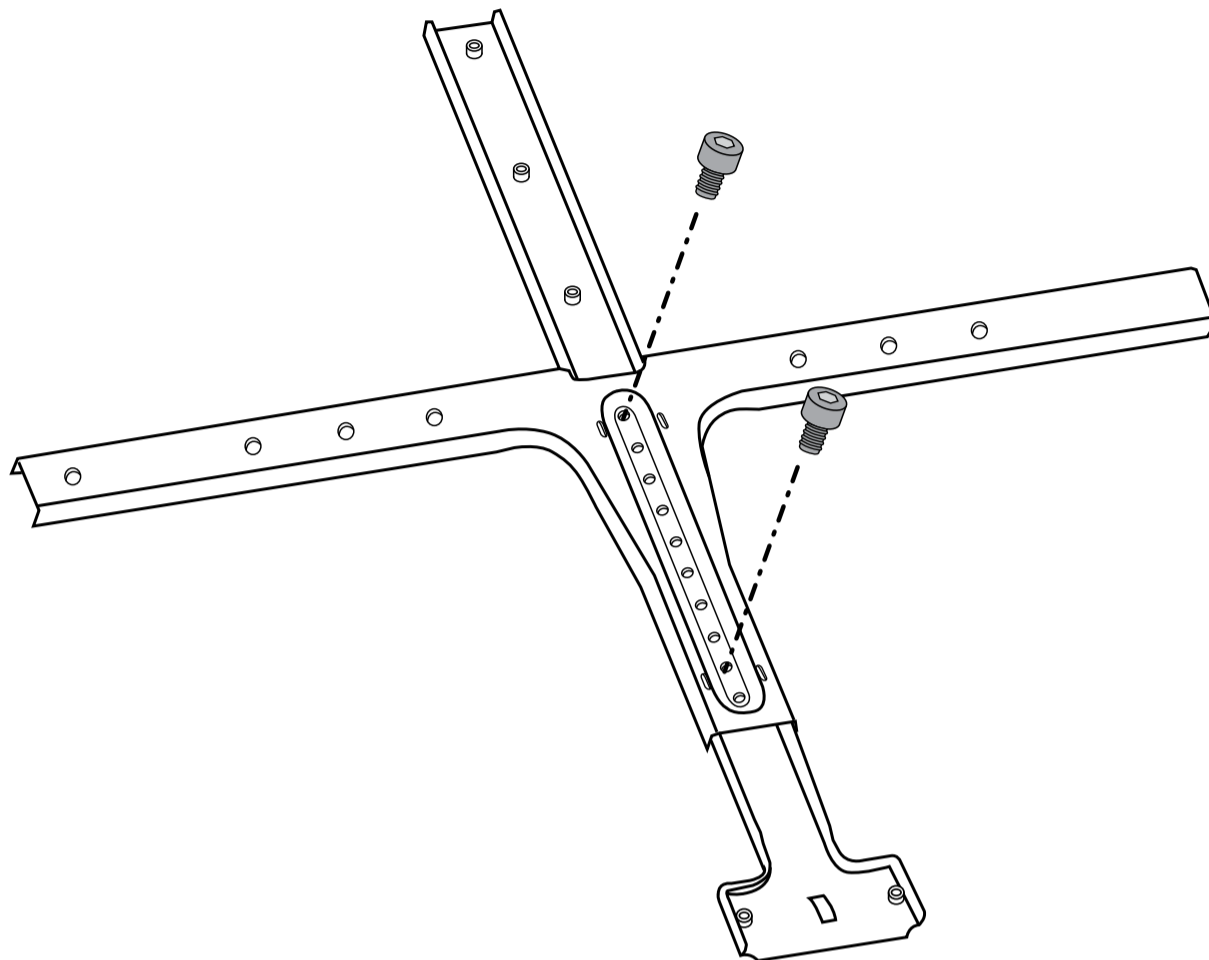
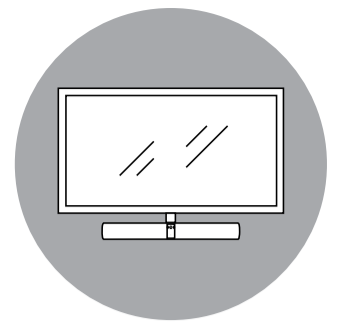



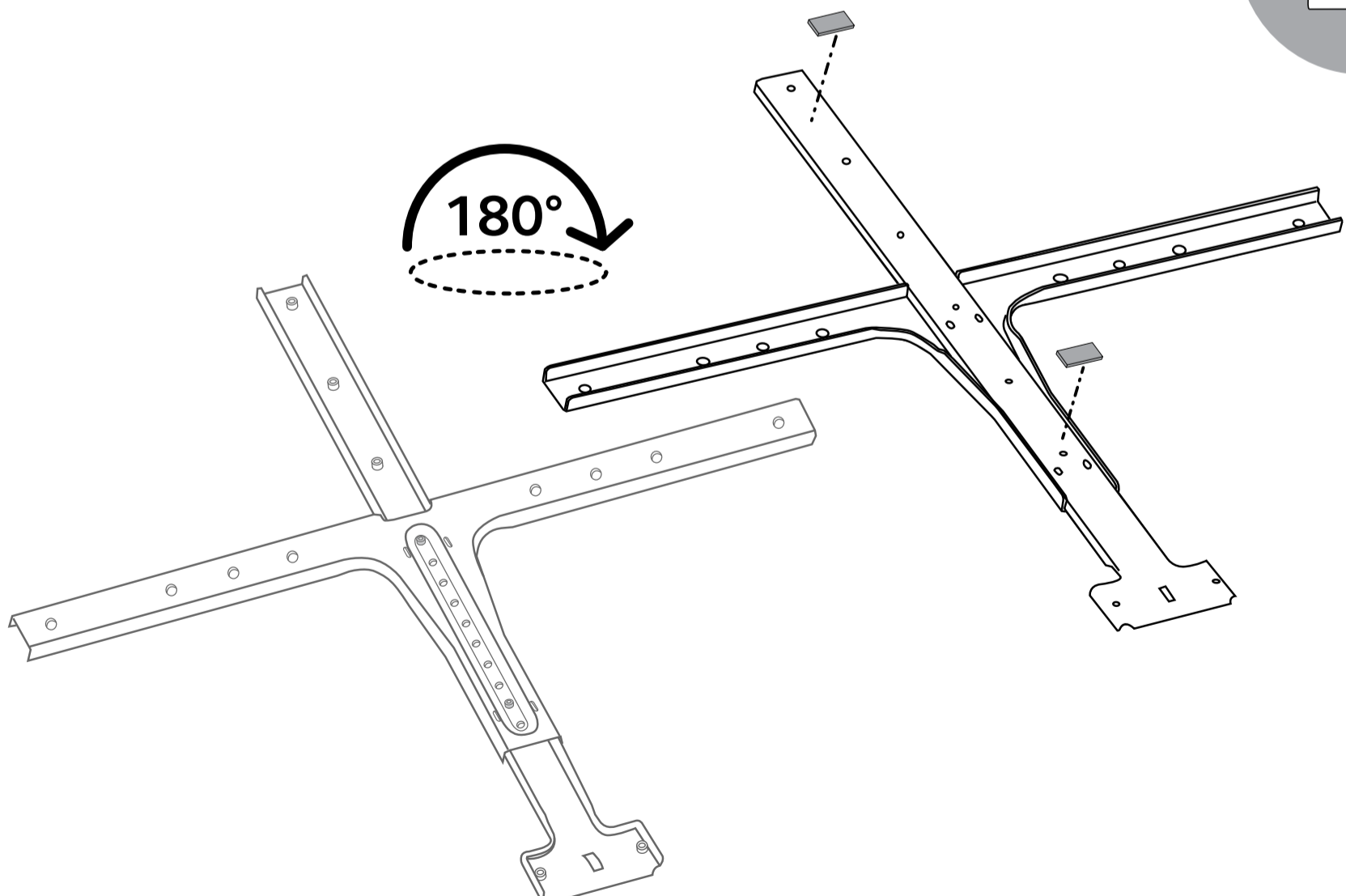
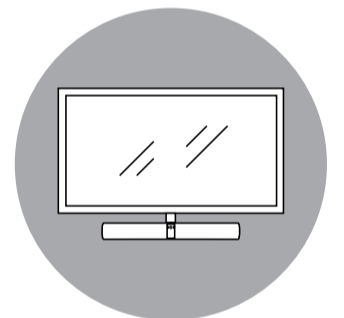

6

Kleben Sie die **Klebe-Schutzpolster** an die Rückseite der Bildschirmhalterung.

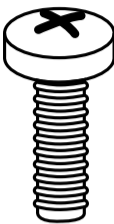
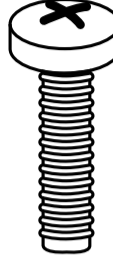
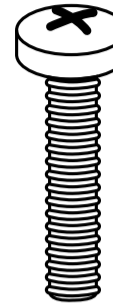
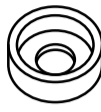

7

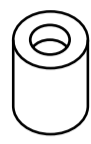
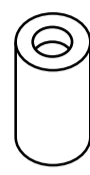
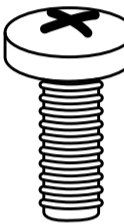
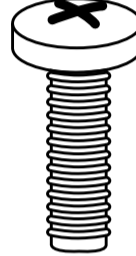
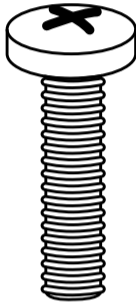
Wählen Sie die Schrauben, Unterlegscheiben und Abstandhalter aus, die am besten zur Kontur Ihres Bildschirms passen.

Schrauben			Abstandhalter				
							
M6x30 (4 Stck.)	M6x40 (4 Stck.)	M6x50 (4 Stck.)	2 mm (2 Stck.)	5 mm (4 Stck.)	12 mm (2 Stck.)	22 mm (4 Stck.)	32 mm (4 Stck.)
Schrauben			Unterlegscheiben				
							
M8x30 (4 Stck.)	M8x40 (4 Stck.)	M8x50 (4 Stck.)	M6 (4 Stck.)	M8 (4 Stck.)			

8

Schrauben Sie die Bildschirmhalterung und die VESA-Halterung (nicht im Lieferumfang enthalten) wie in der Abbildung gezeigt an den Bildschirm. Verwenden Sie dabei den Abstandhalter mit der passenden Länge für die obersten Schrauben.

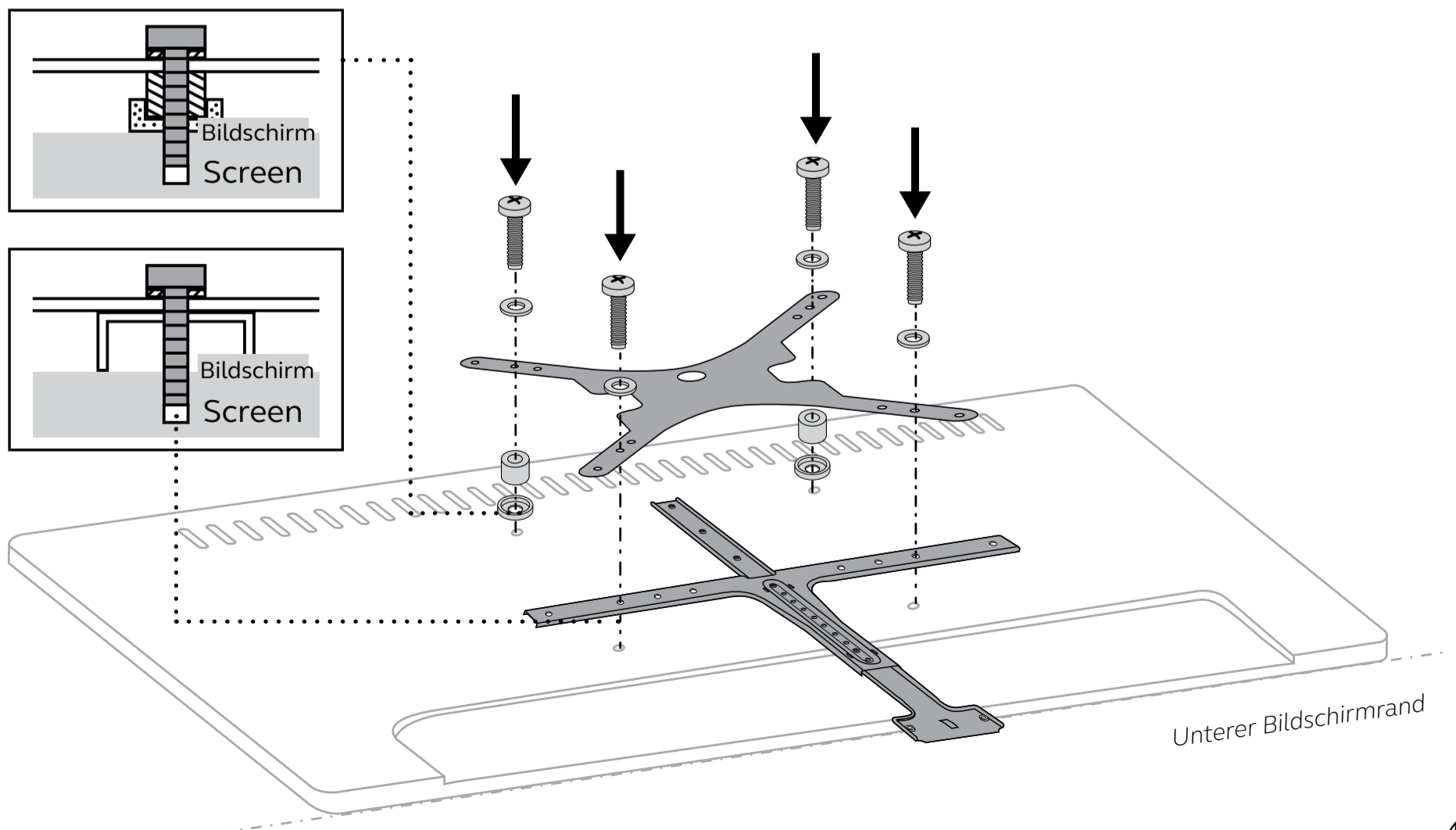
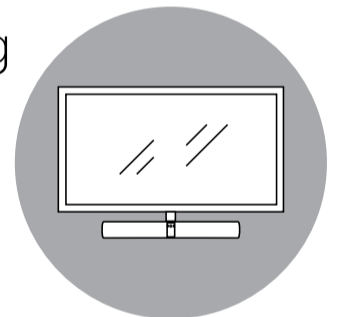

9

Neigen Sie das Scharnier an der PanaCast 50, um besser an die Schraubenlöcher zu kommen.

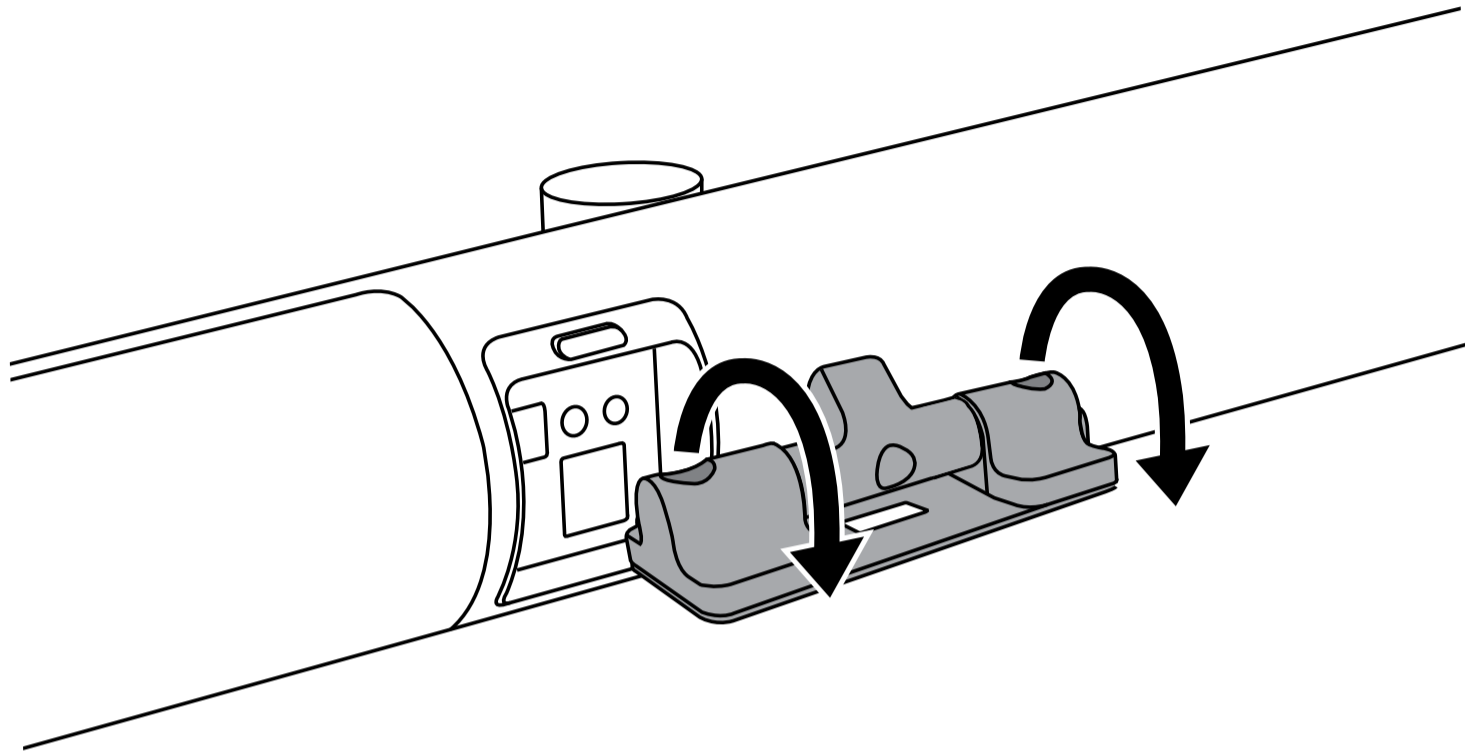
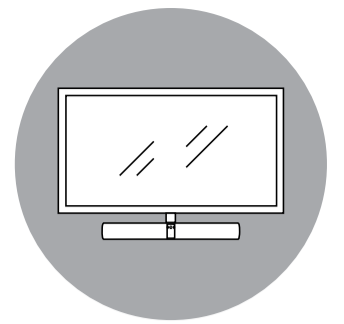

10

Befestigen Sie die PanaCast 50 mithilfe der mitgelieferten **M5x12-Schrauben** und eines **4-mm-Sechskantschlüssels** an der Wandhalterung.

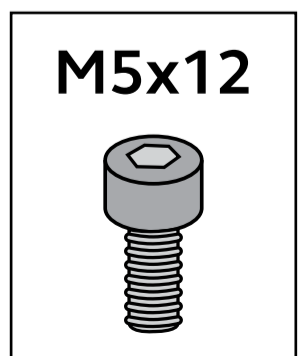
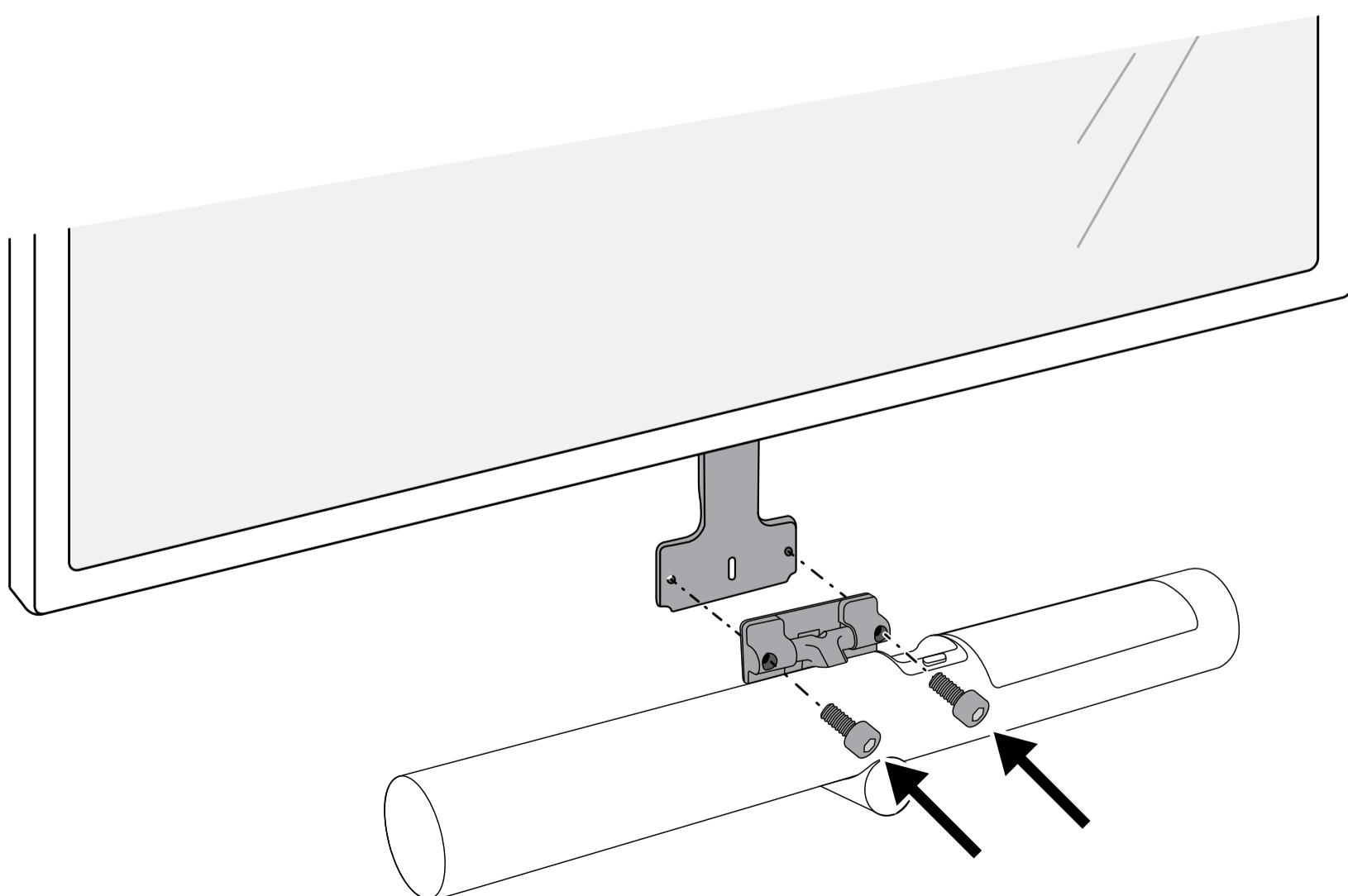
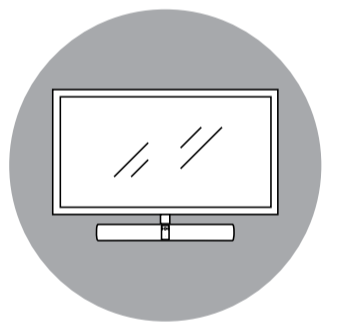

11

Drehen Sie die PanaCast 50 in ihre endgültige Position und richten Sie die Kamera so aus, dass sie auf Augenhöhe der Meeting-Teilnehmer zeigt.

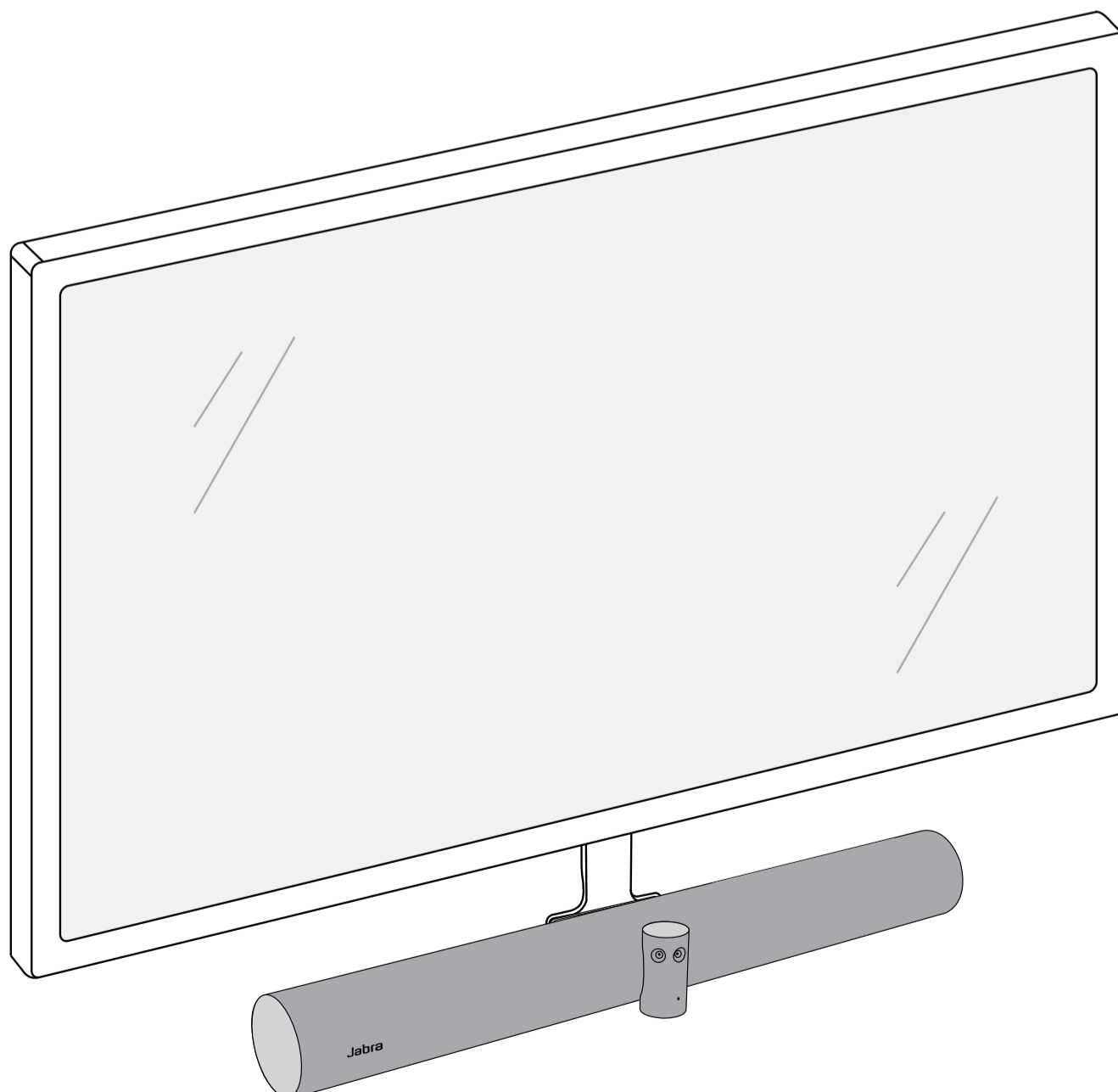
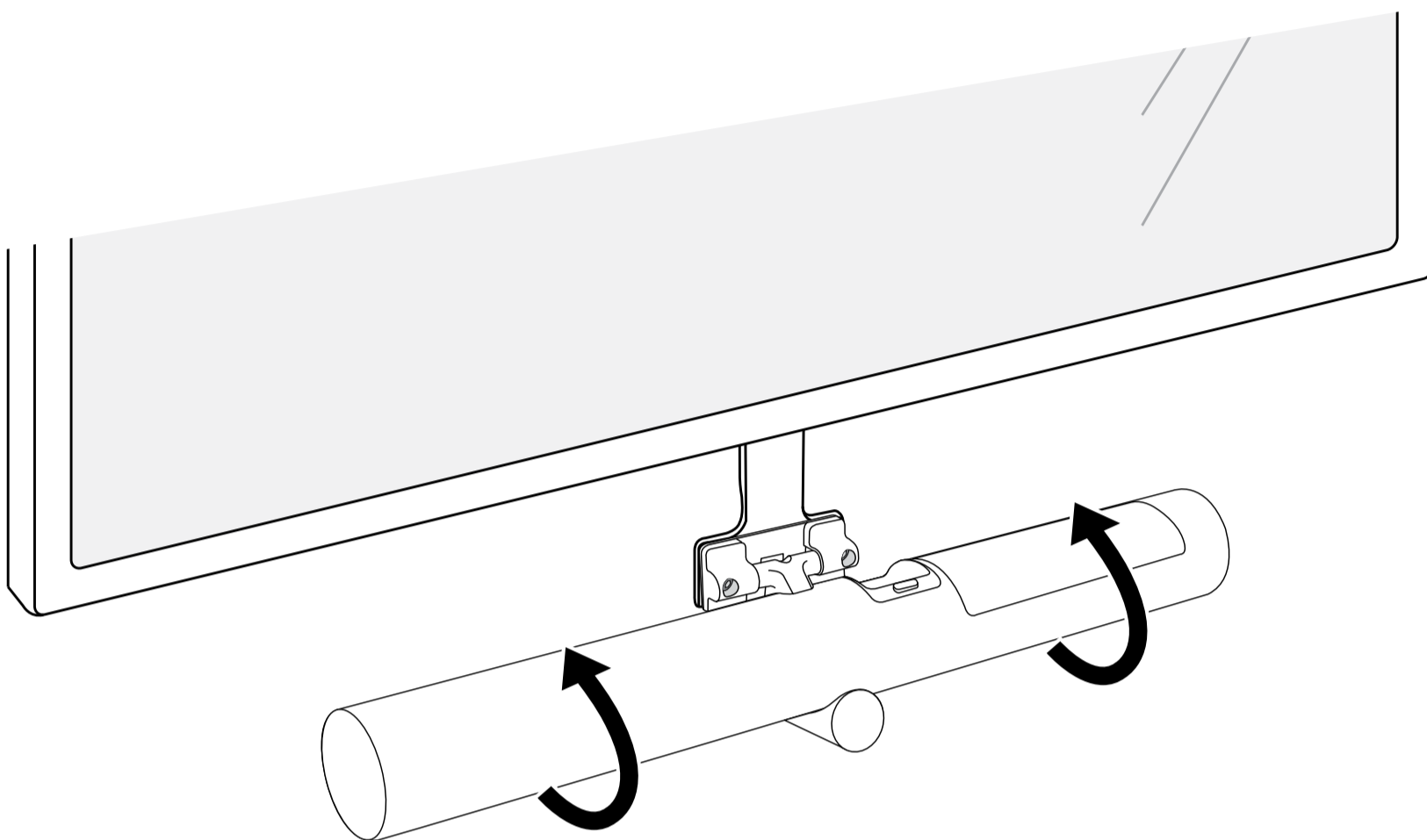
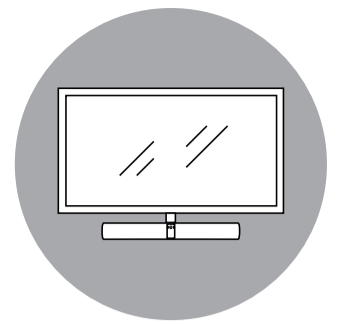

1

Wenn der Bildschirm bereits an der Wand montiert ist, nehmen Sie ihn von der Wand ab.

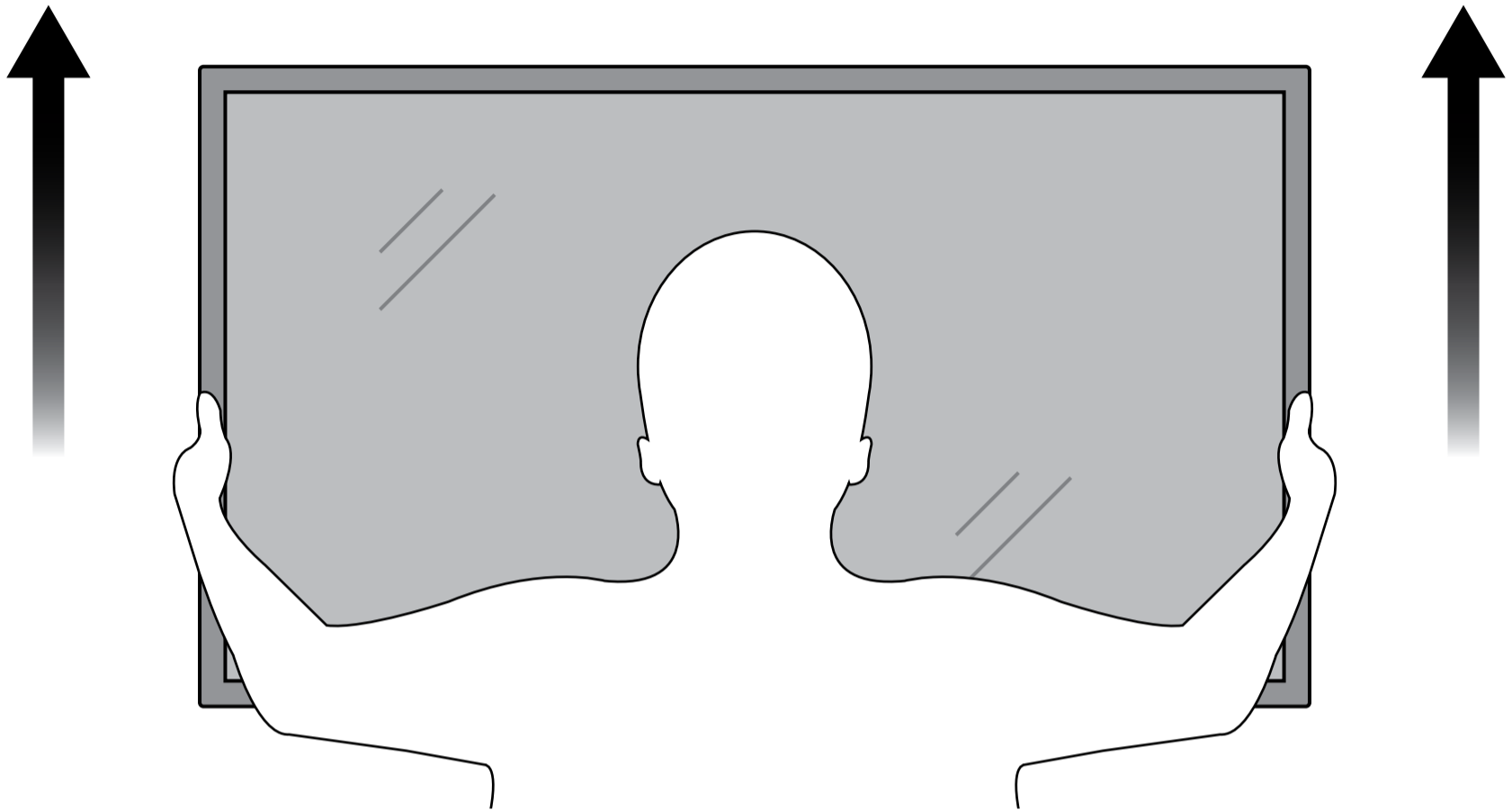
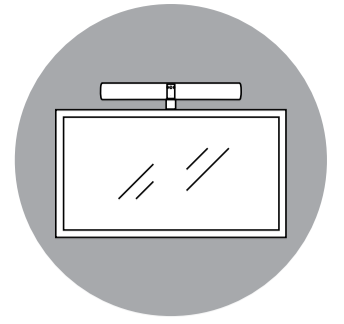

2

Entfernen Sie die vorhandene **VESA-Halterung** von Ihrem Bildschirm.

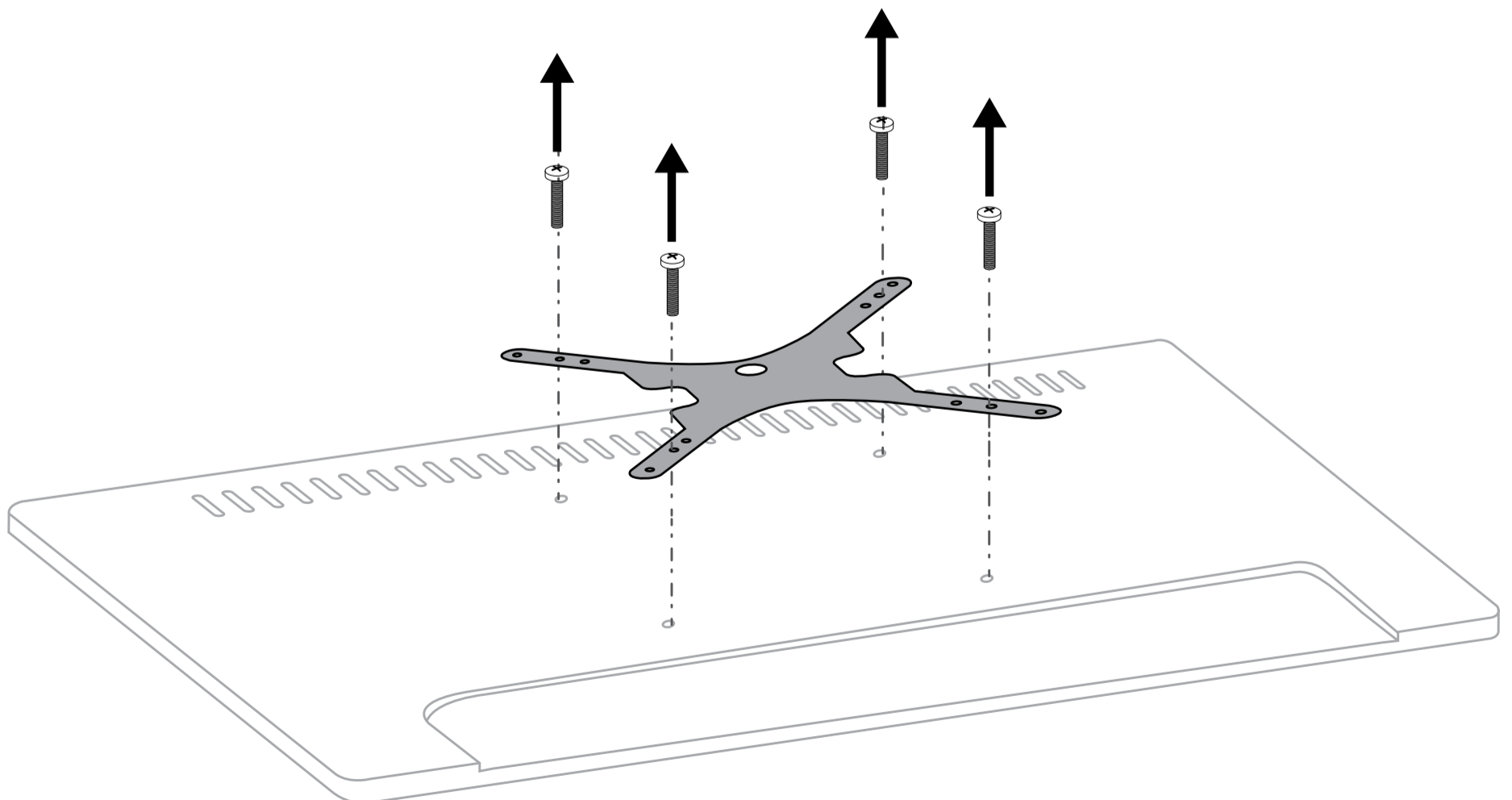

3

Messen Sie den Abstand zwischen dem Bohrloch der VESA-Halterung und dem oberen Bildschirmrand. Dieser Abstand ist **X**.

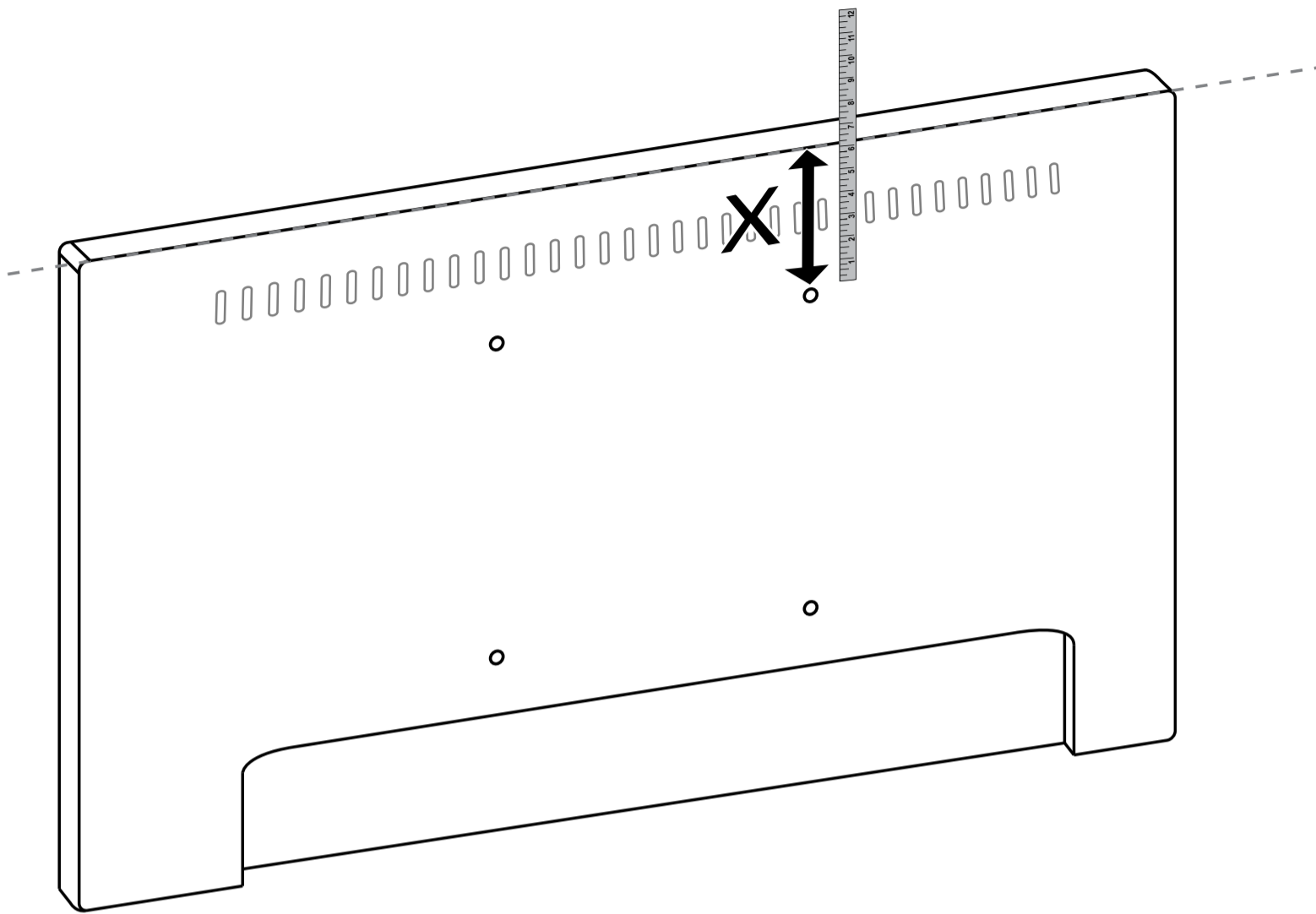
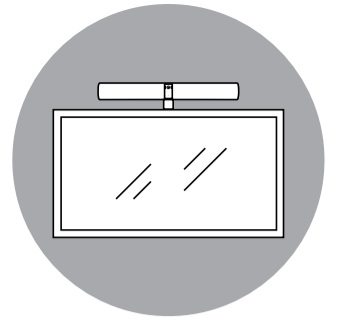

4

Bauen Sie die Bildschirmhalterung zusammen und vergewissern Sie sich, dass der angezeigte Abstand ungefähr **X + 10 cm** beträgt.

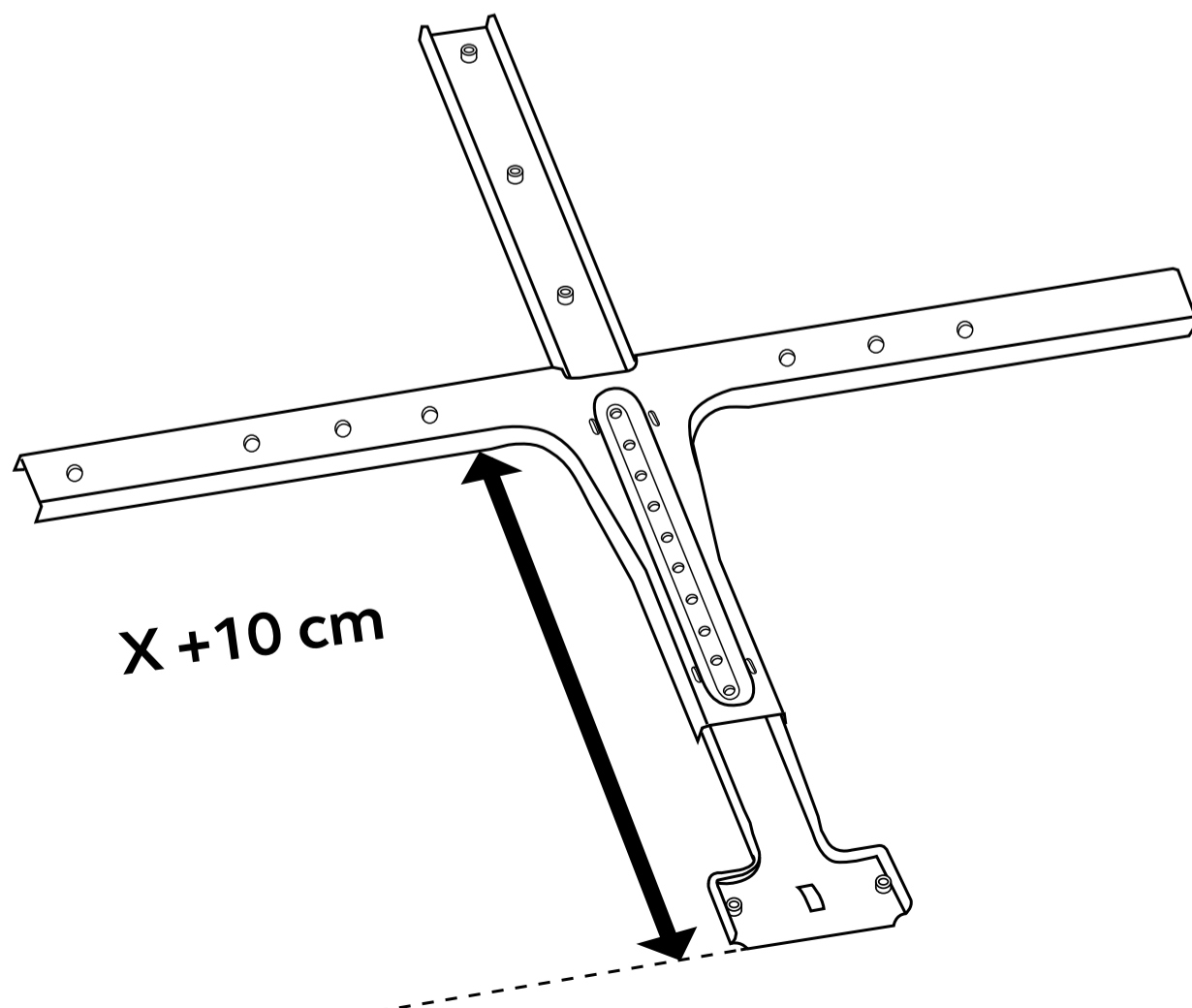
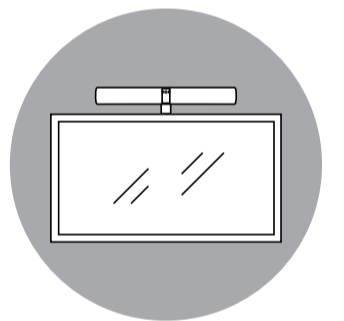

5

Schrauben Sie den horizontalen und den vertikalen Abschnitt mithilfe der mitgelieferten **M5x8-Schrauben** und eines **4-mm-Sechskantschlüssels** zusammen.

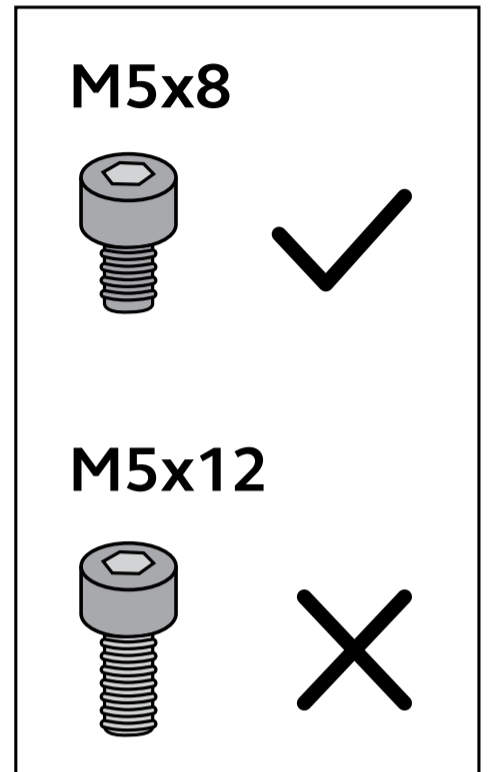
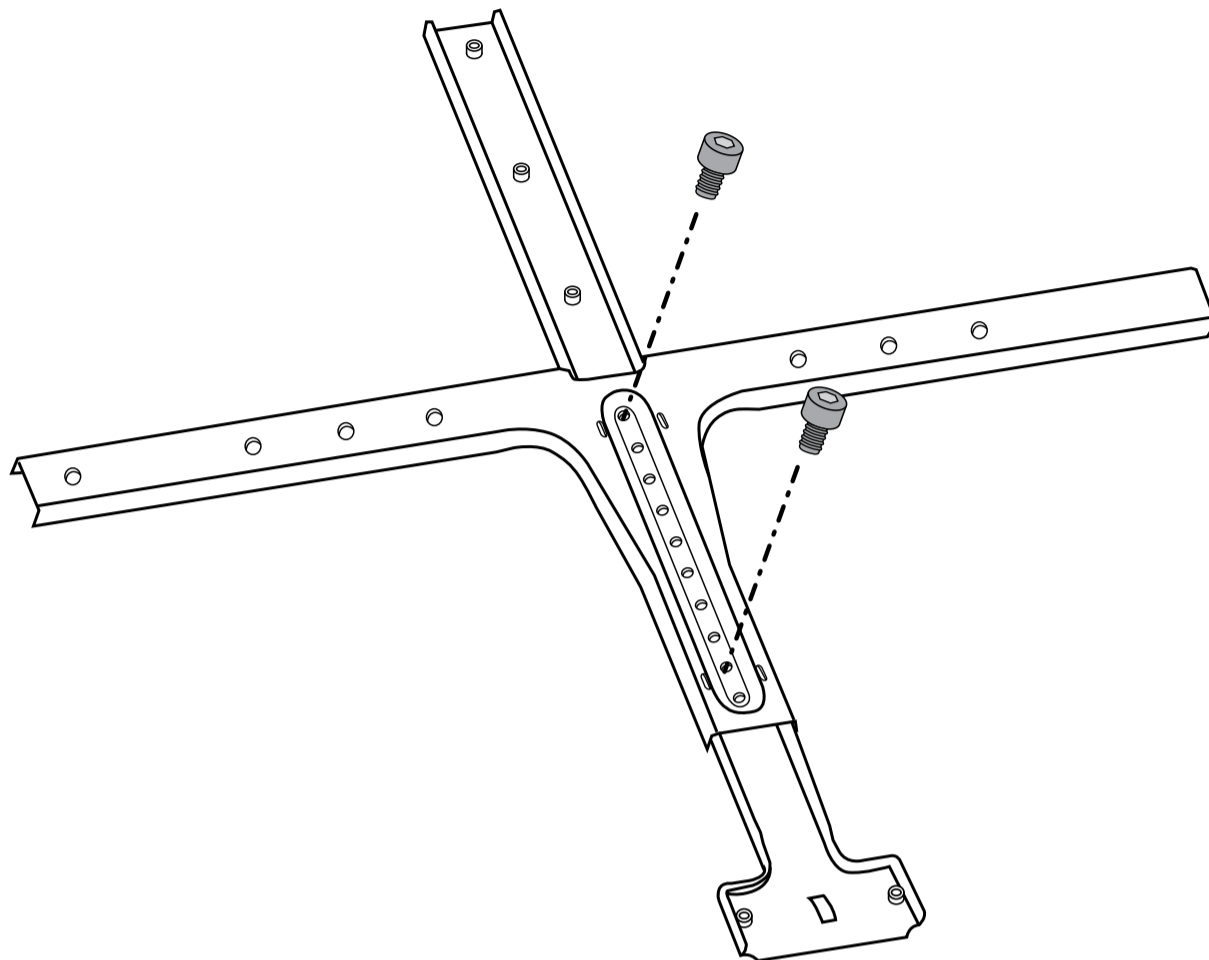
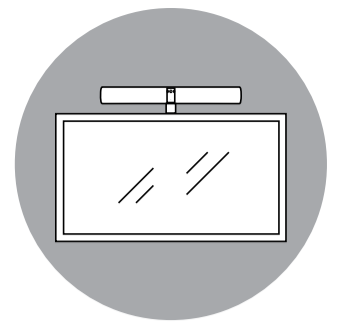





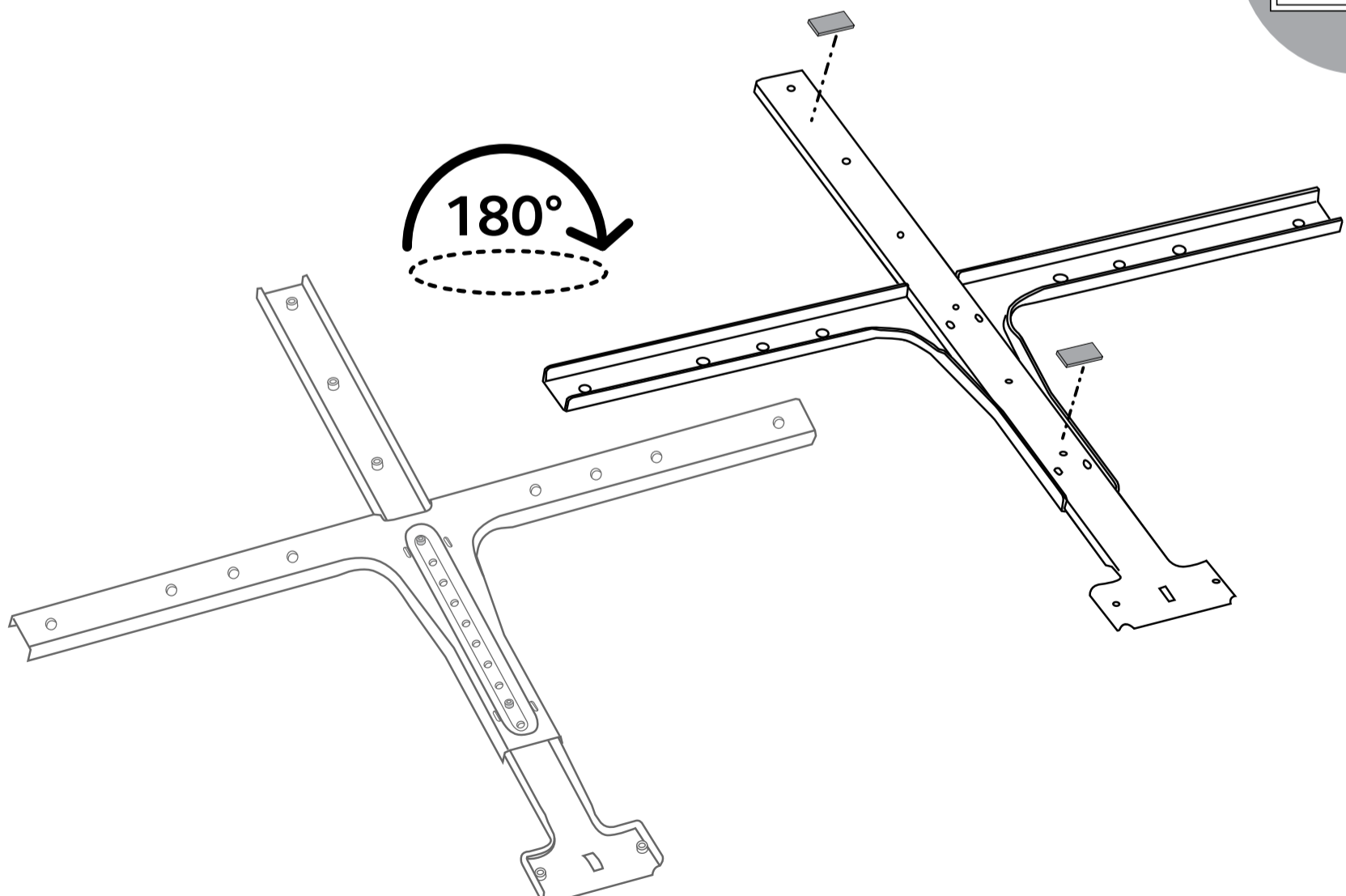
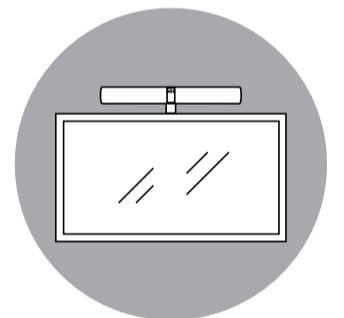

6

Kleben Sie die **Klebe-Schutzpolster** an die Rückseite der Bildschirmhalterung.

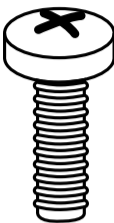
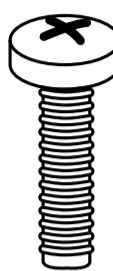
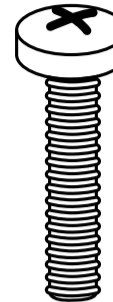
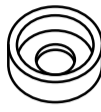

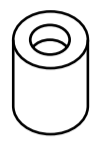
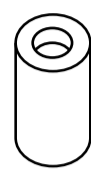
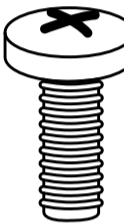
7

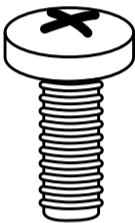
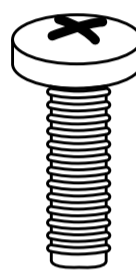
Wählen Sie die Schrauben, Unterlegscheiben und Abstandhalter aus, die am besten zur Kontur Ihres Bildschirms passen.

Schrauben			Abstandhalter				
							
M6x30 (4 Stck.)	M6x40 (4 Stck.)	M6x50 (4 Stck.)	2 mm (2 Stck.)	5 mm (4 Stck.)	12 mm (2 Stck.)	22 mm (4 Stck.)	32 mm (4 Stck.)
Schrauben			Unterlegscheiben				
							
M8x30 (4 Stck.)	M8x40 (4 Stck.)	M8x50 (4 Stck.)	M6 (4 Stck.)	M8 (4 Stck.)			

8

Schrauben Sie die Bildschirmhalterung und die VESA-Halterung (nicht im Lieferumfang enthalten) wie in der Abbildung gezeigt an den Bildschirm. Verwenden Sie dabei den Abstandhalter mit der passenden Länge für die obersten Schrauben.

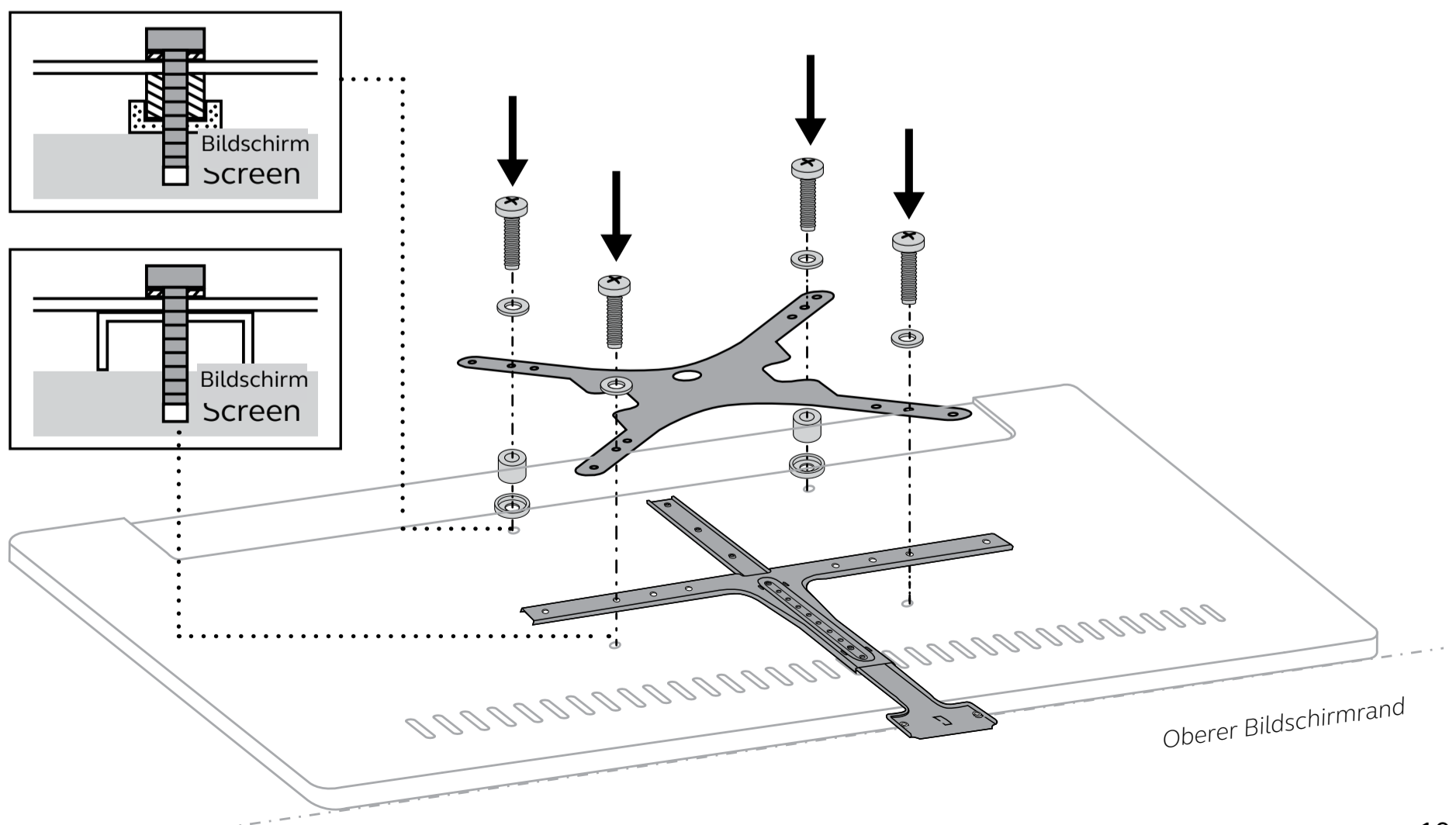
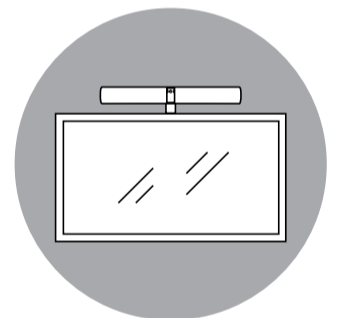

9

Neigen Sie das Scharnier an der PanaCast 50, um besser an die Schraubenlöcher zu kommen.

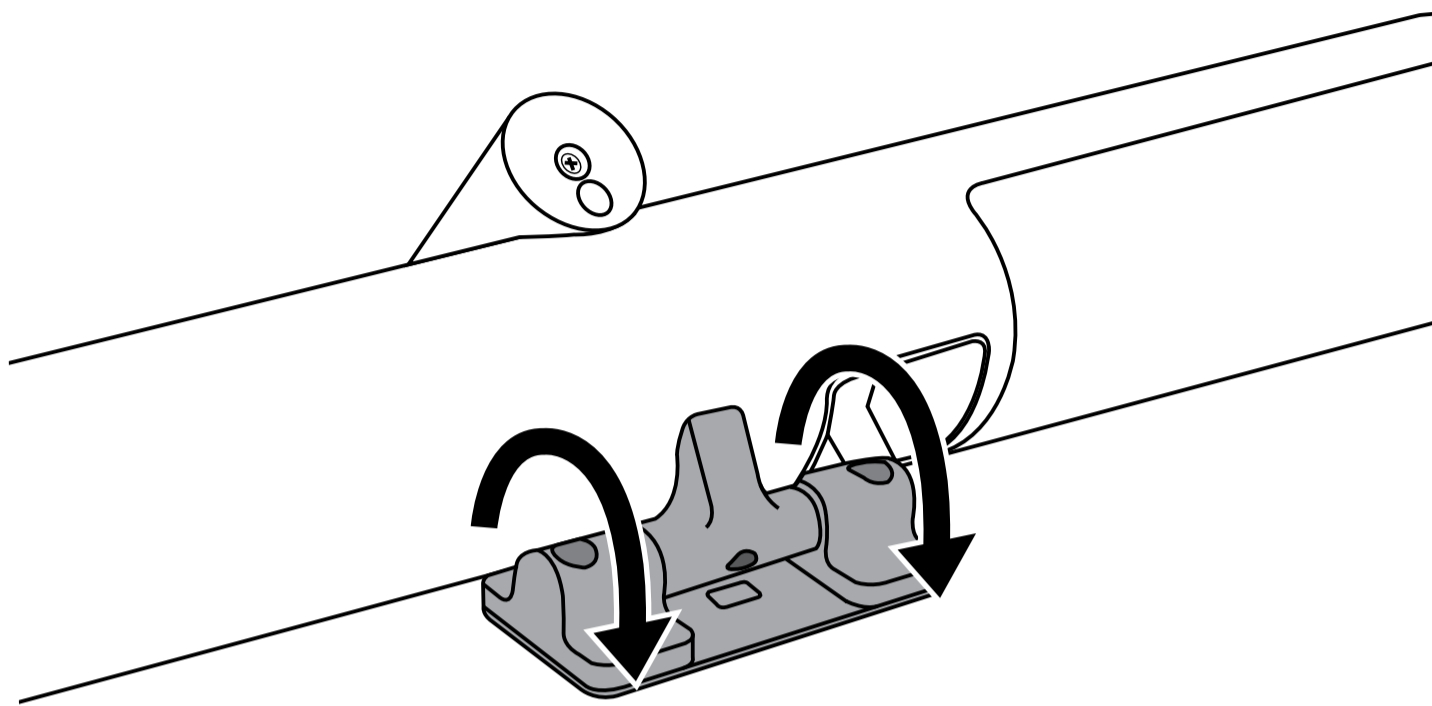
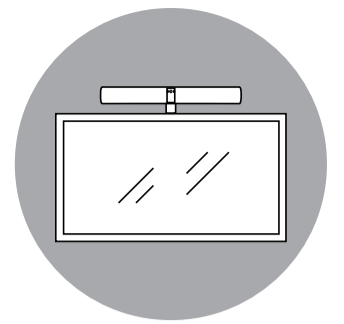

10

Befestigen Sie die PanaCast 50 mithilfe der mitgelieferten **M5x12-Schrauben** und eines **4-mm-Sechskantschlüssels** an der Wandhalterung.

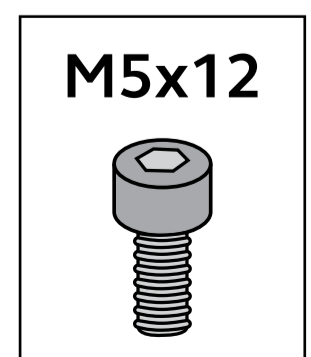
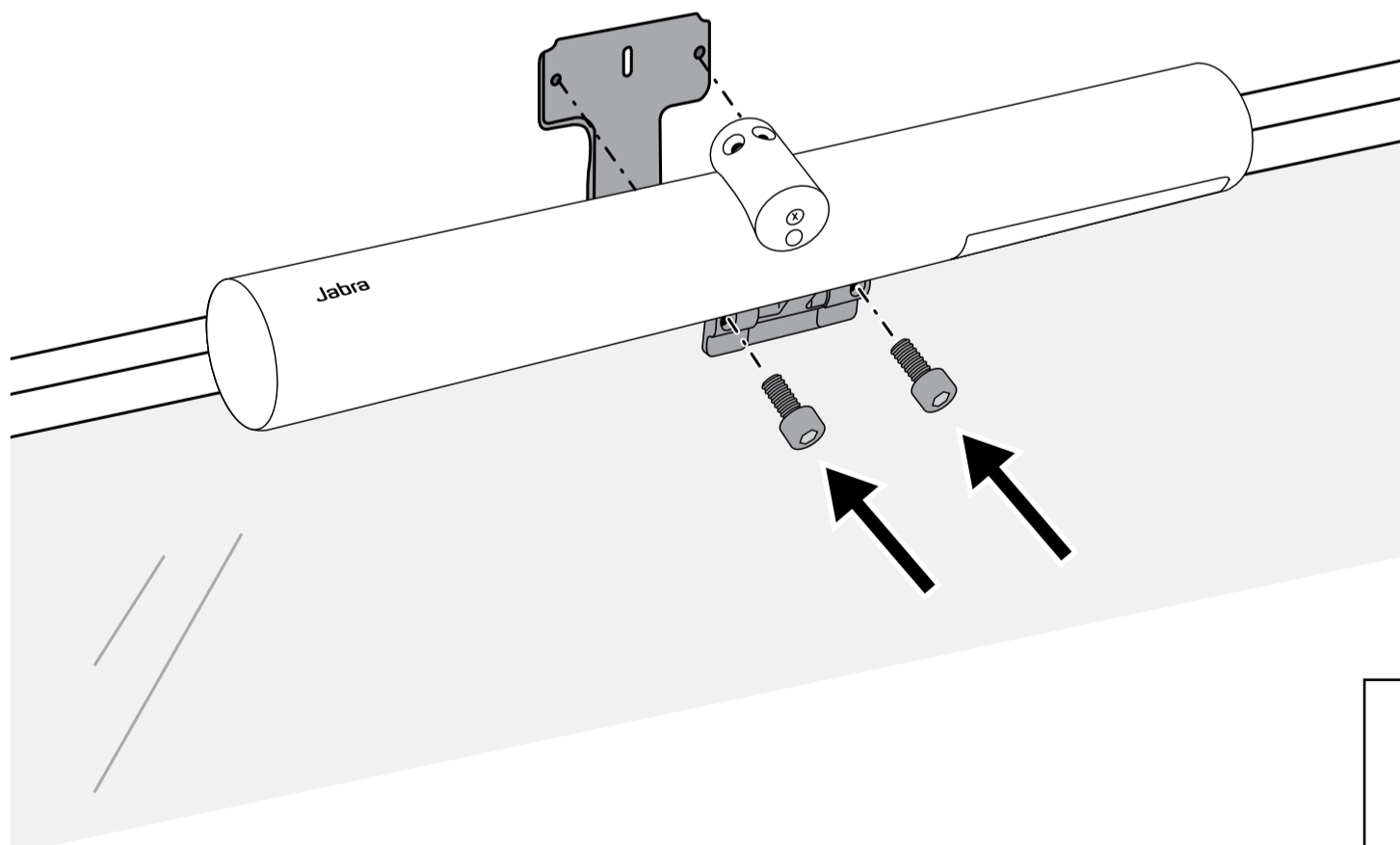
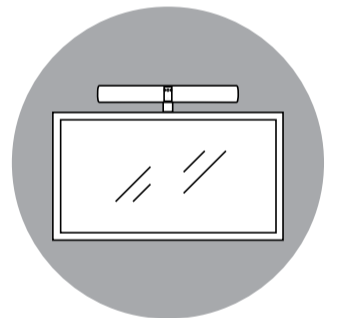

11

Drehen Sie die PanaCast 50 in ihre endgültige Position und richten Sie die Kamera so aus, dass sie auf Augenhöhe der Meeting-Teilnehmer zeigt.

